

REV.	ECN NO.	DESCRIPTION	DESIGN	DATE
A		INITIAL	Kai	2018.03.29

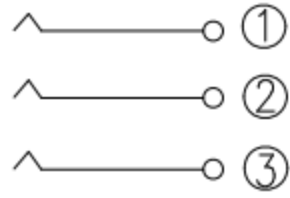

CIRCUIT

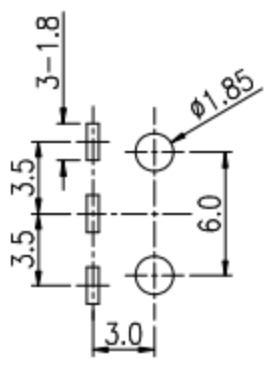
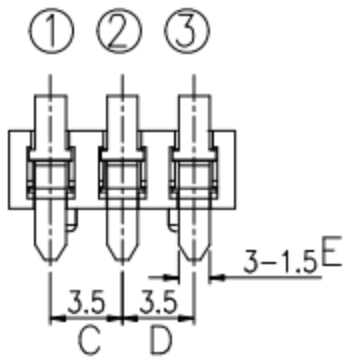
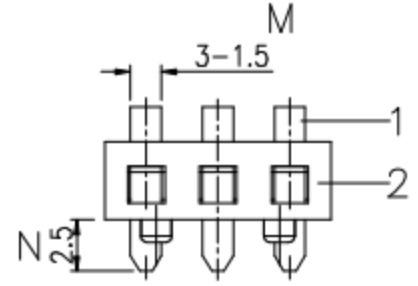
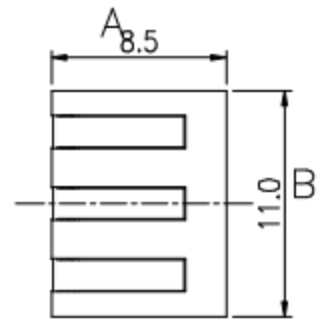

P.C.B LAYOUT

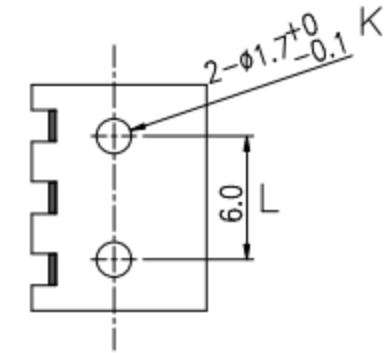
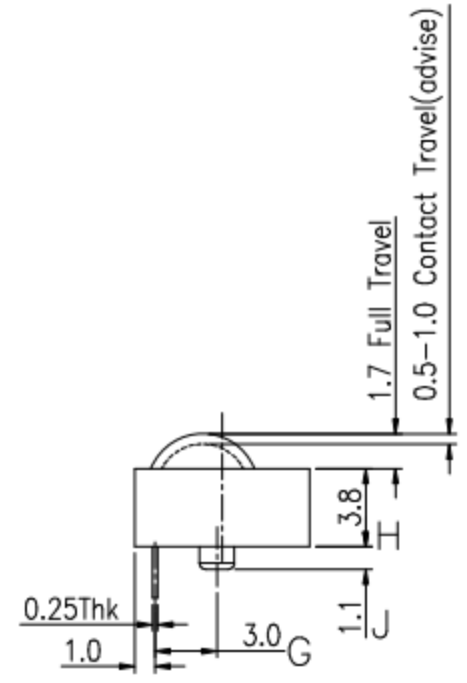

性能:
 额定电流: 3.0A
 额定电压: 24V
 耐电压: 500V
 接触电阻: 30mΩ MAX
 绝缘电阻: 500MΩ
 工作温度: -40℃~+85℃
 塑件(材质): LCP, 耐高温260℃
 接触点(材质): 铜合金, 触点镀金3U'

②	HOUSING	1	LCP		BLACK
①	CONTACT A	2	PHOSPHOR BRONZE 0.20T	Au PLATED	
ITEM	PART NAME	Q'TY	MATERTAL	DESCRIPTION	REMARK

UNLESS OTHERWISE SPECIFIED TOLERANCES

DECIMALS:		ANGLES:	
DIM	TOL	DIM	TOL
X.	±0.50	X.	±2°
X.X	±0.30	X.X	±1°
X.XX	±0.20	X.XX	
X.XXX	±0.10	X.XXX	

东莞市高迪电子有限公司

DWG NO.	PART NAME:
DESIGN:	PART NO.
CHECK:	REV. UNIT: SHEET:
APPROVED	A mm 1/1